

Ericofon[®]

SERVICE
AND SPARE PARTS
INSTRUCTION

PART 2

REGISTRERAD
20/Gad 15 JAN 1973
Tillhör

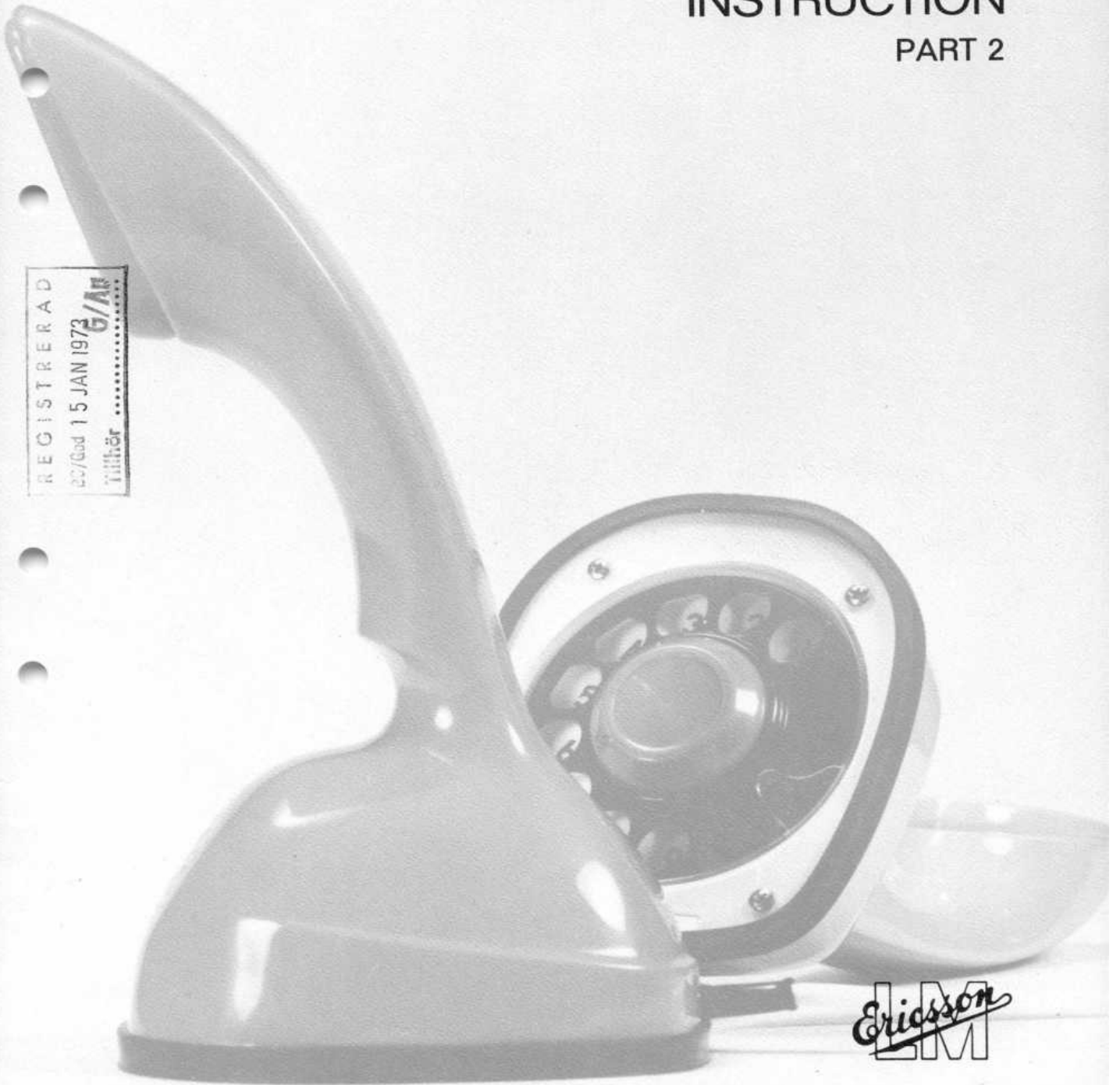

Ericsson
LM

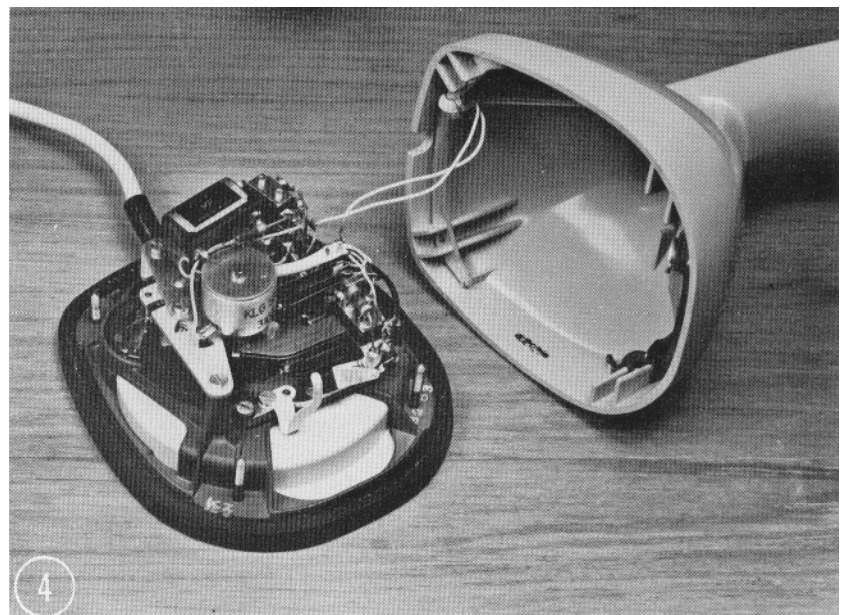
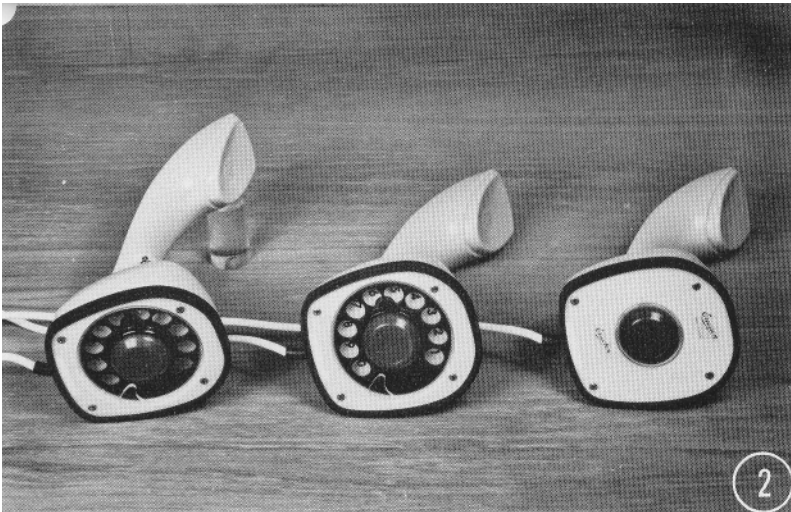
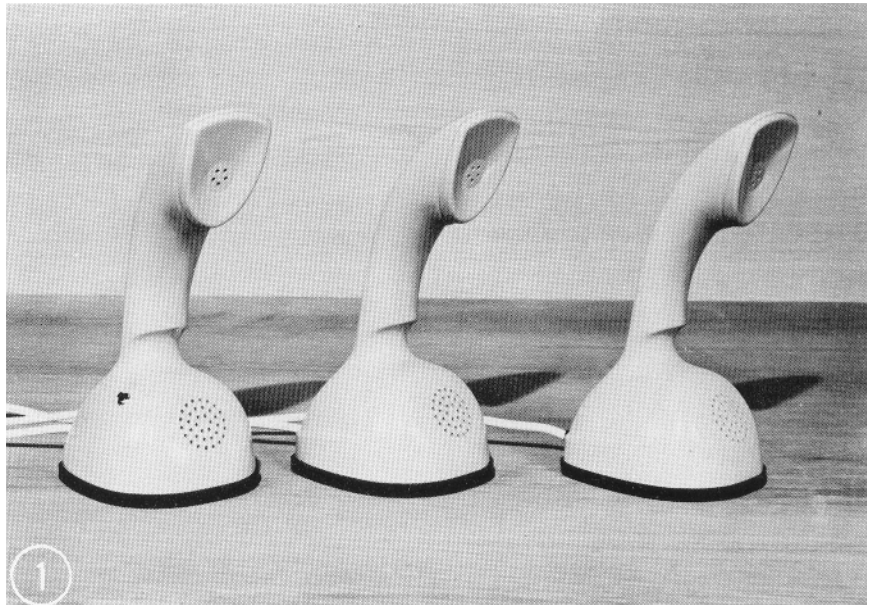

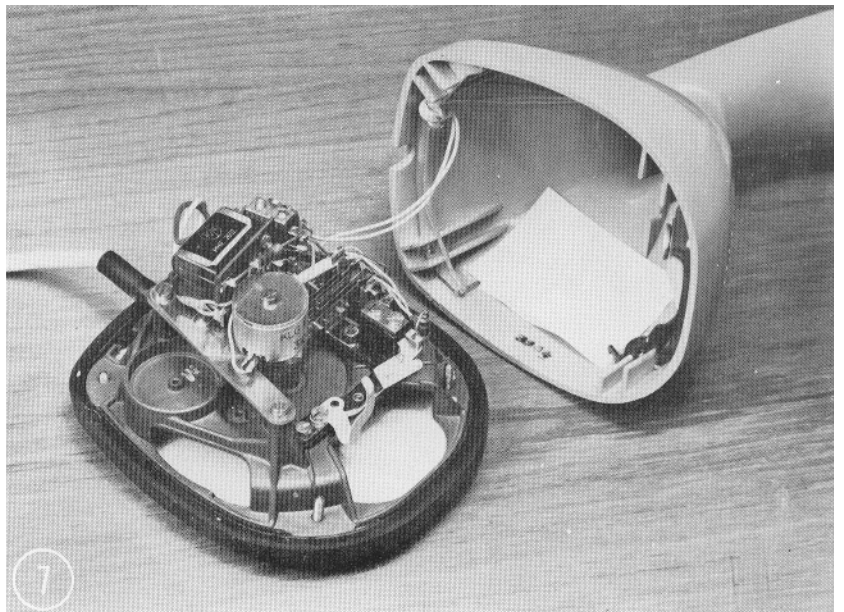
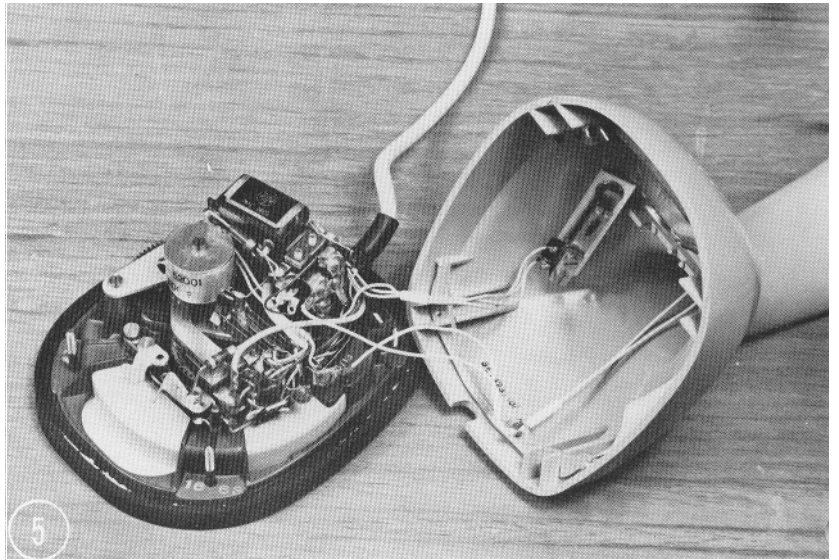

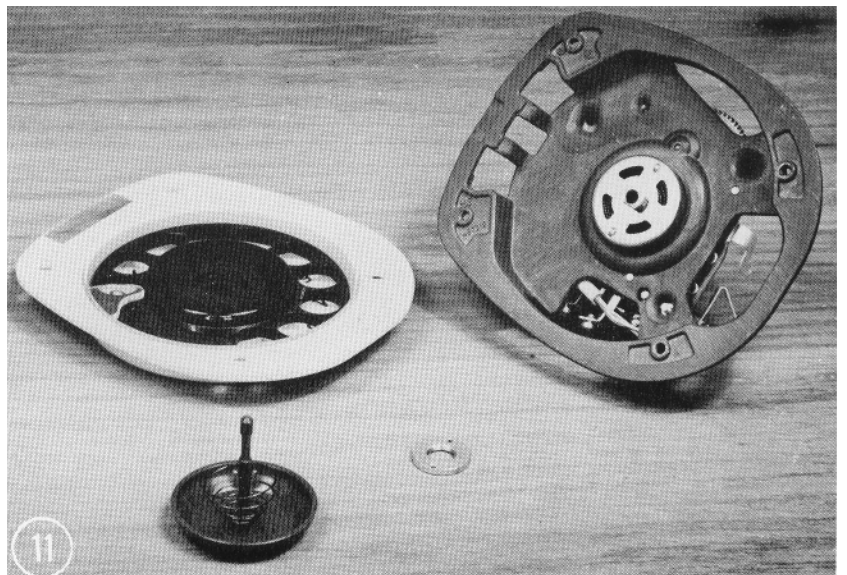
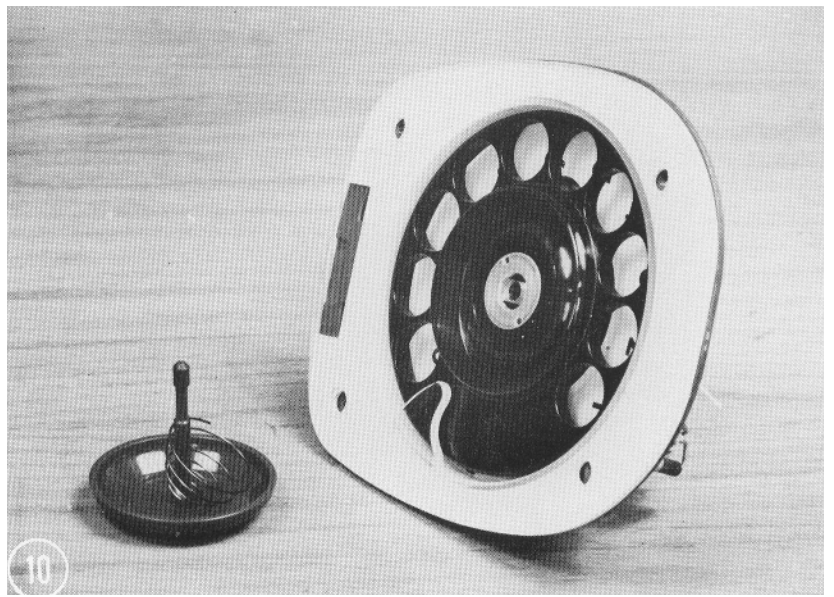
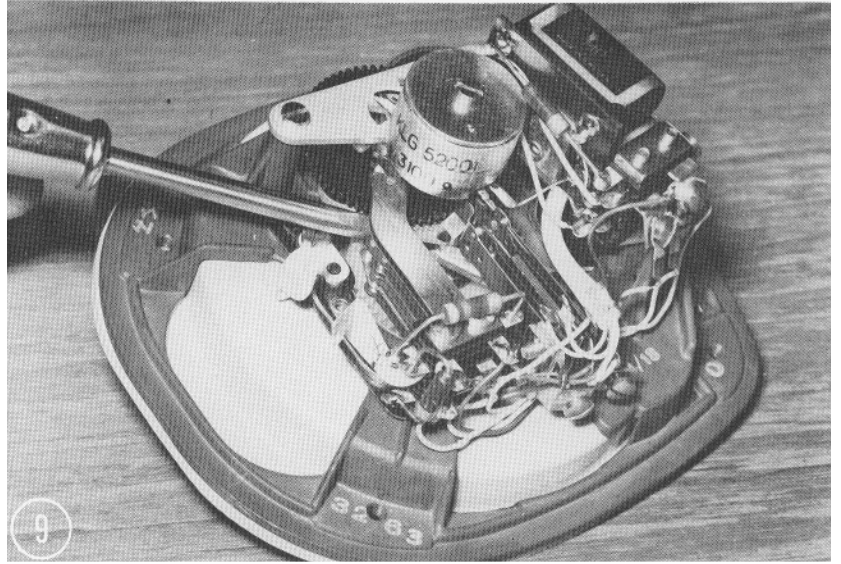
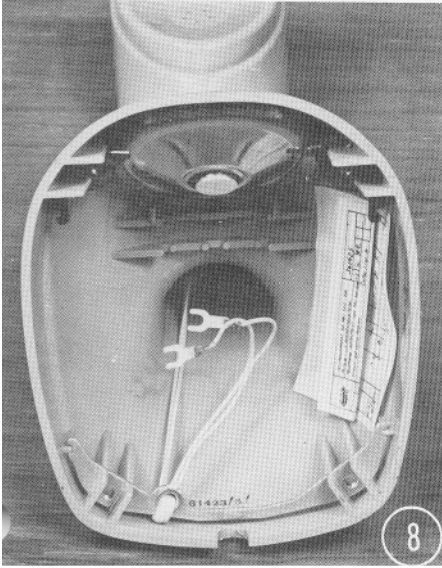

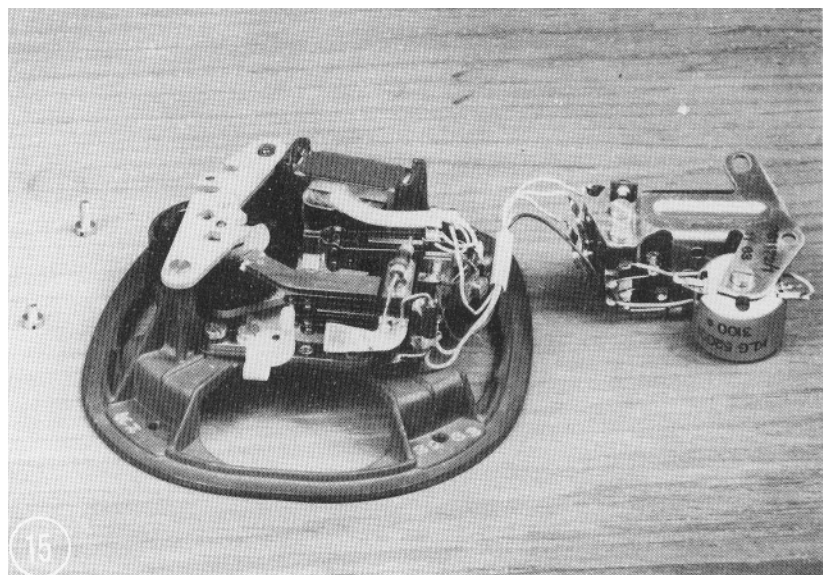
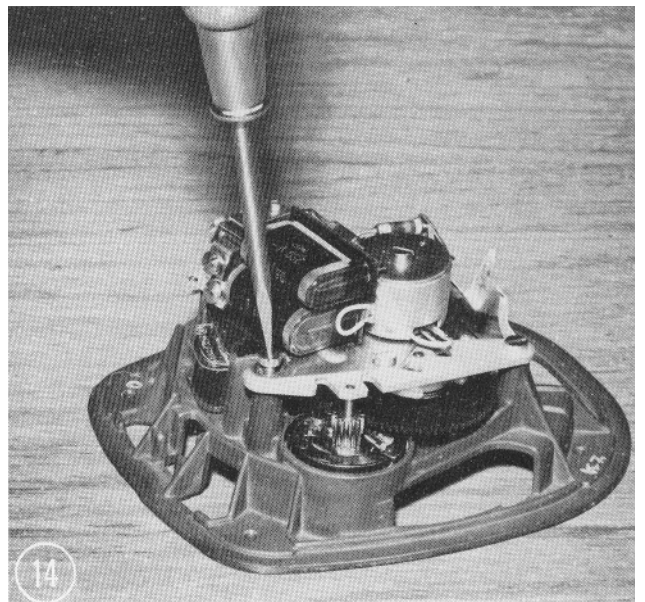
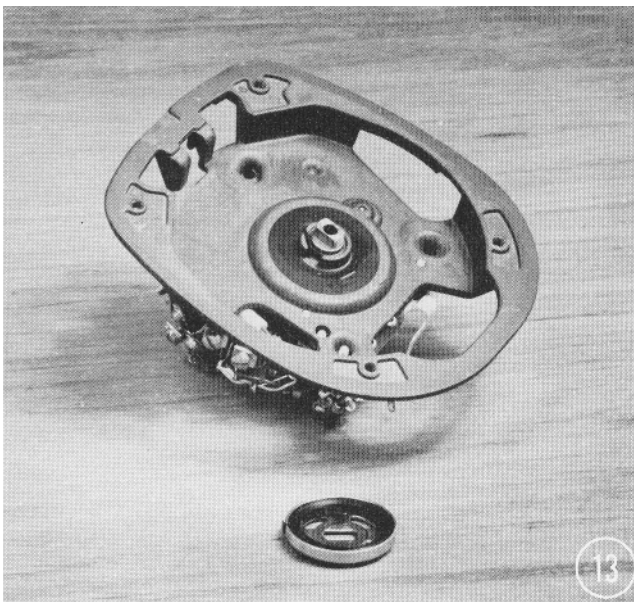
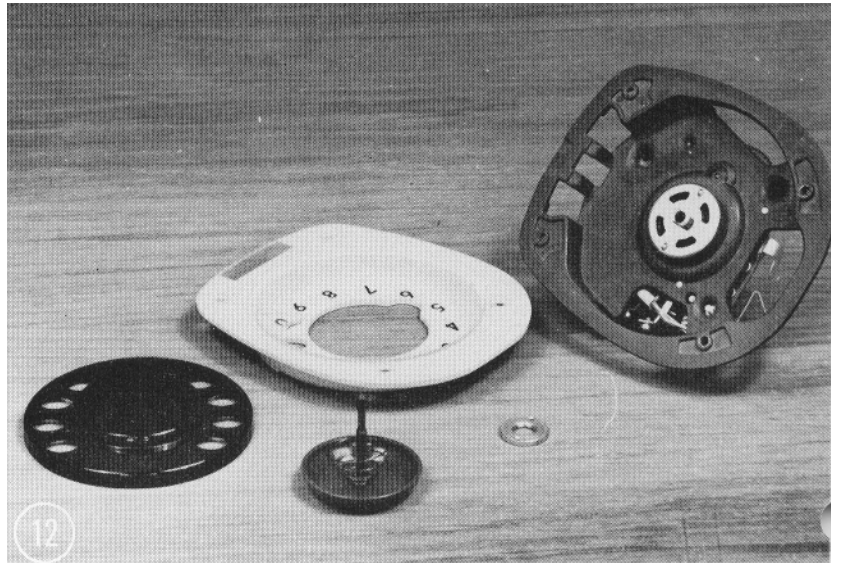

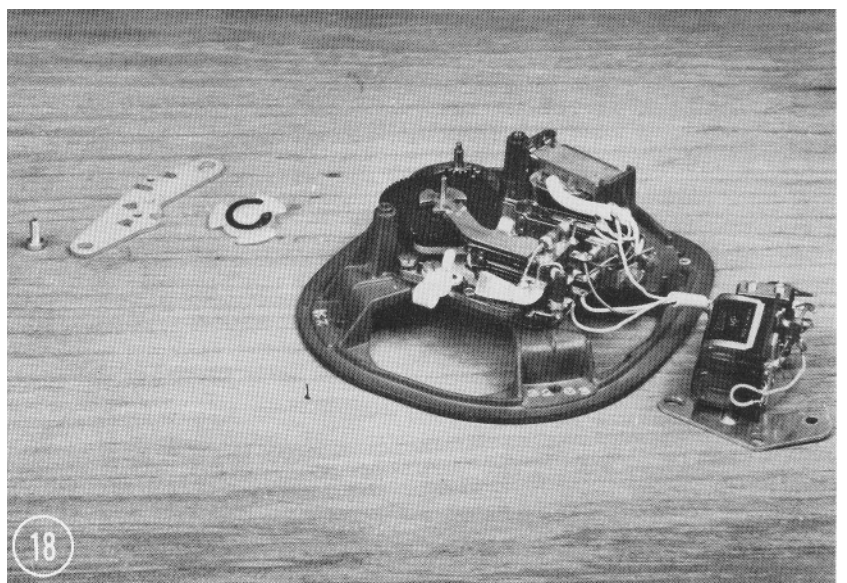
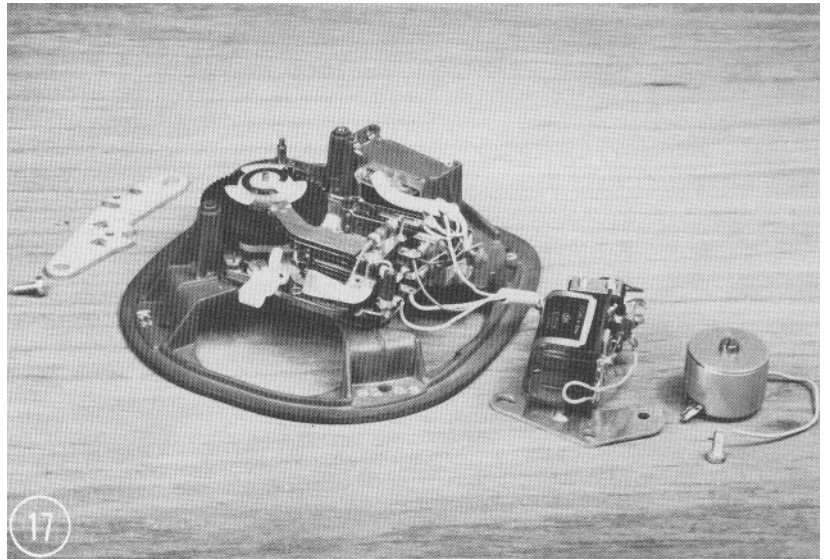
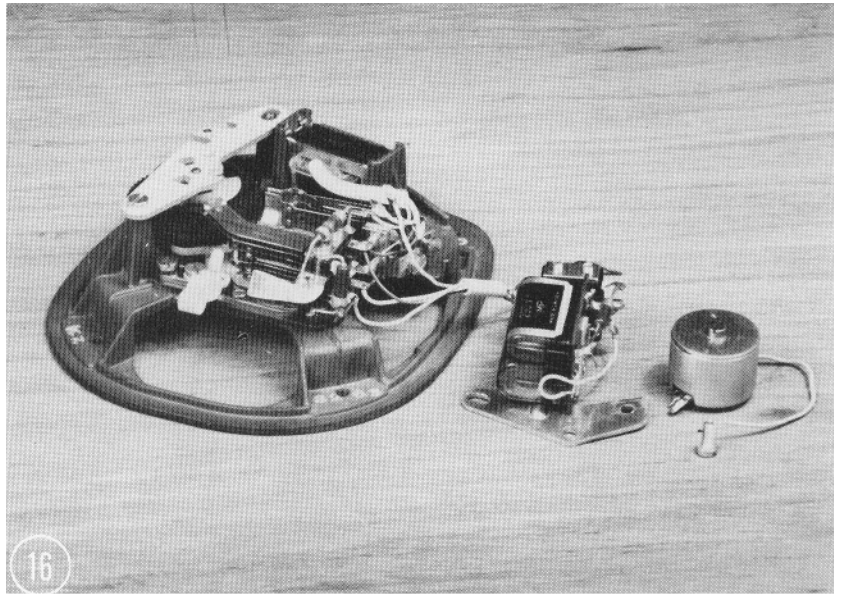

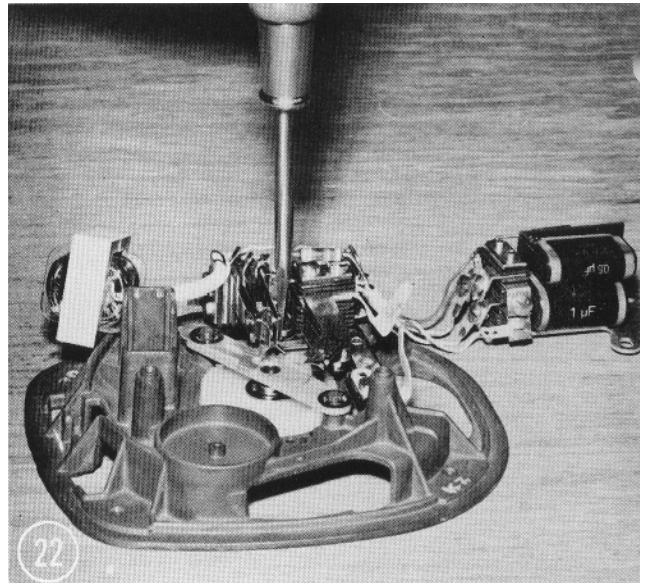
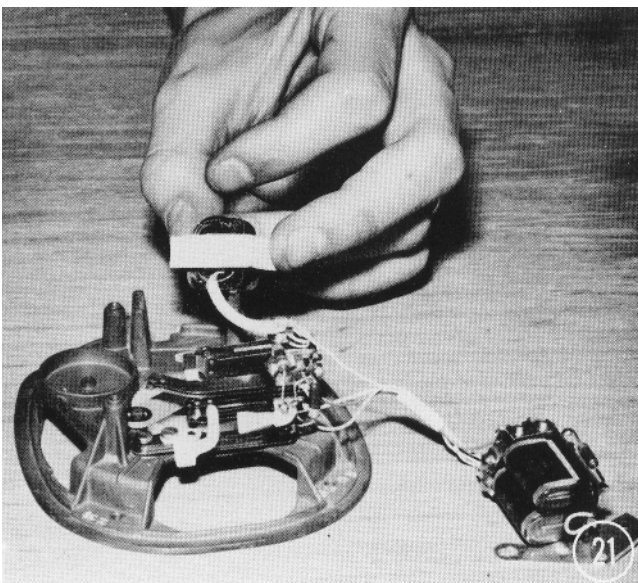
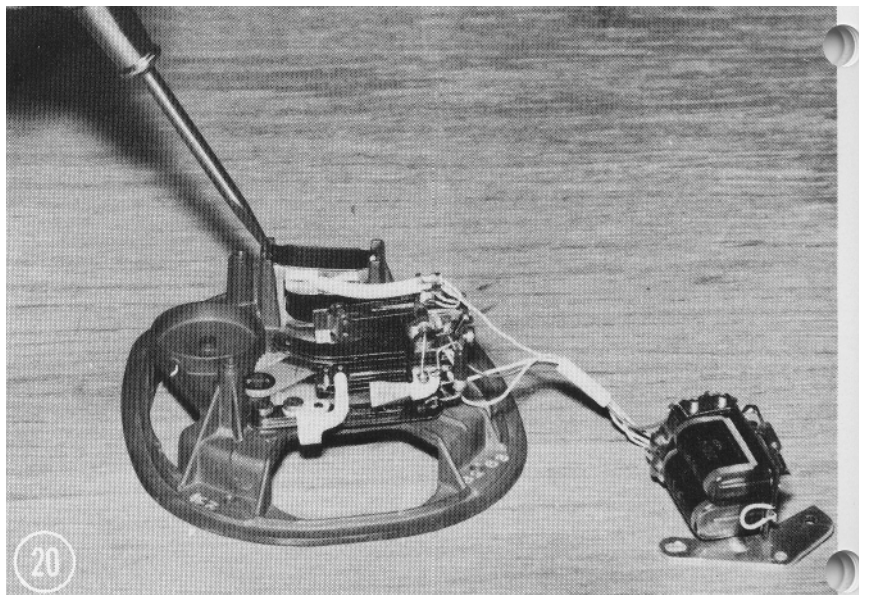
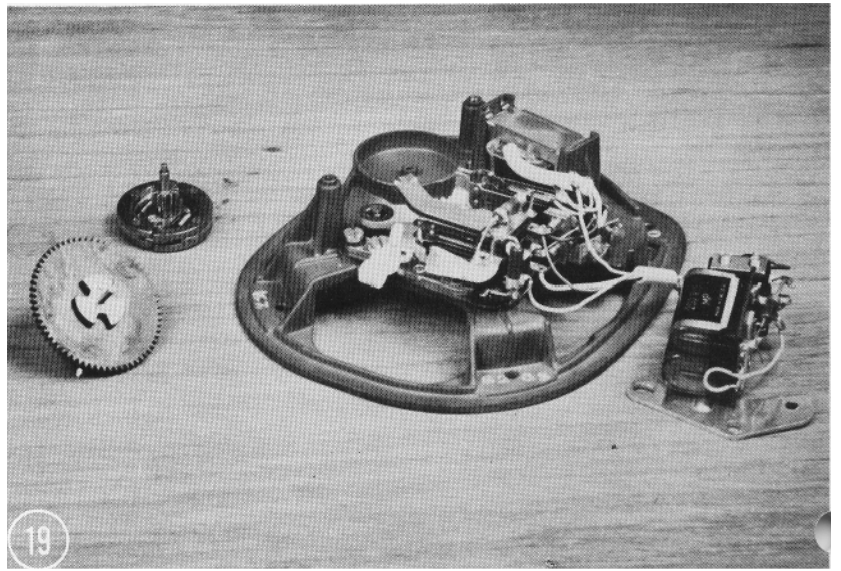

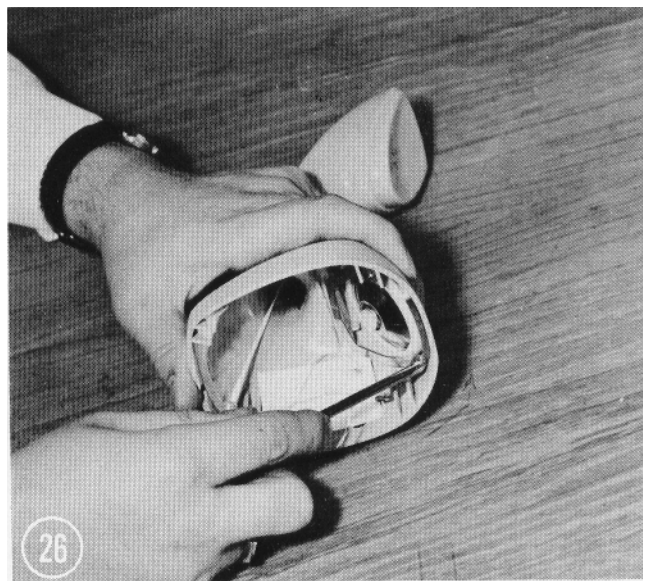
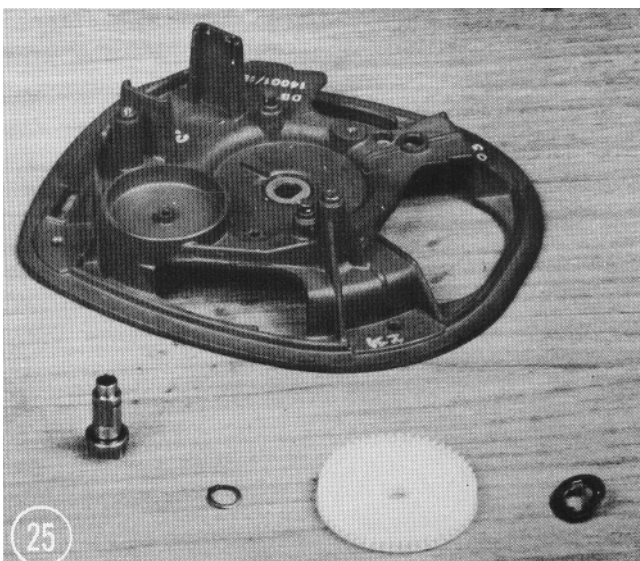
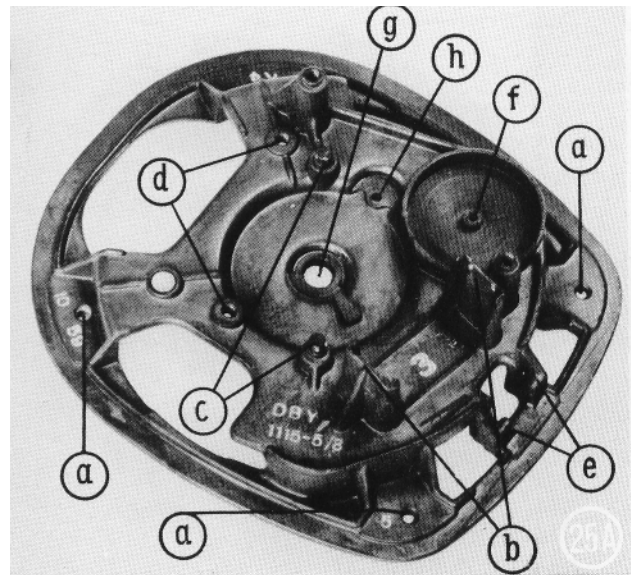
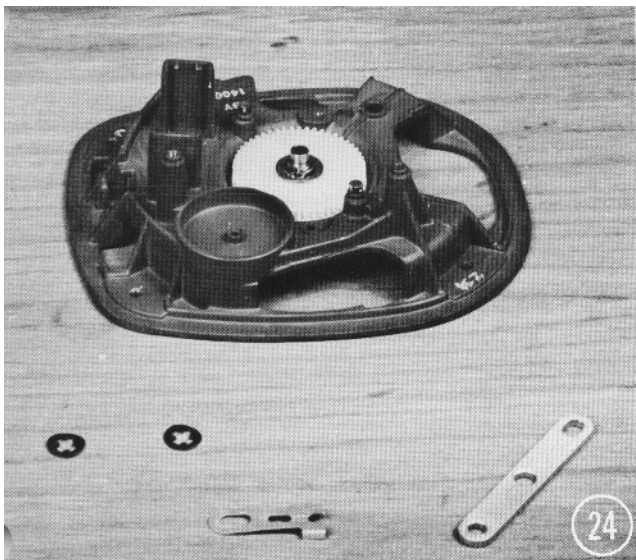
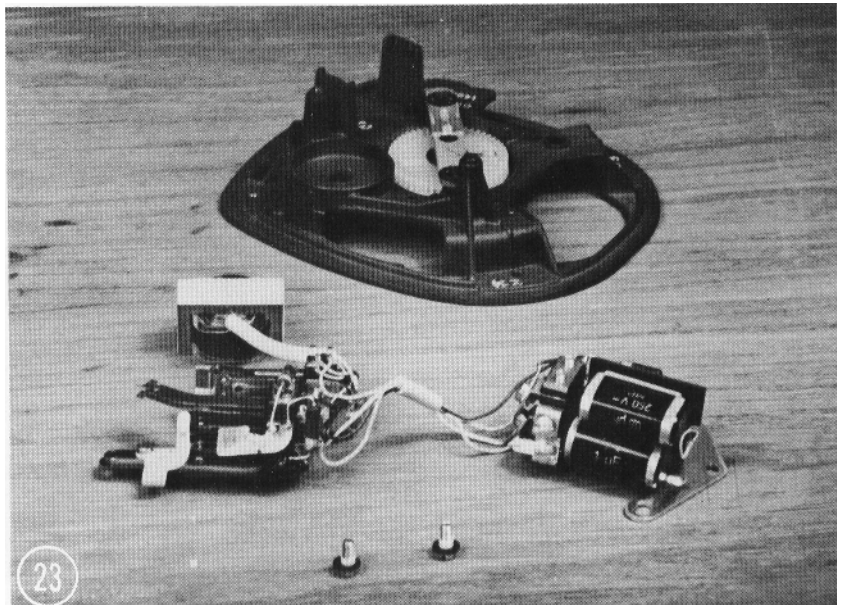

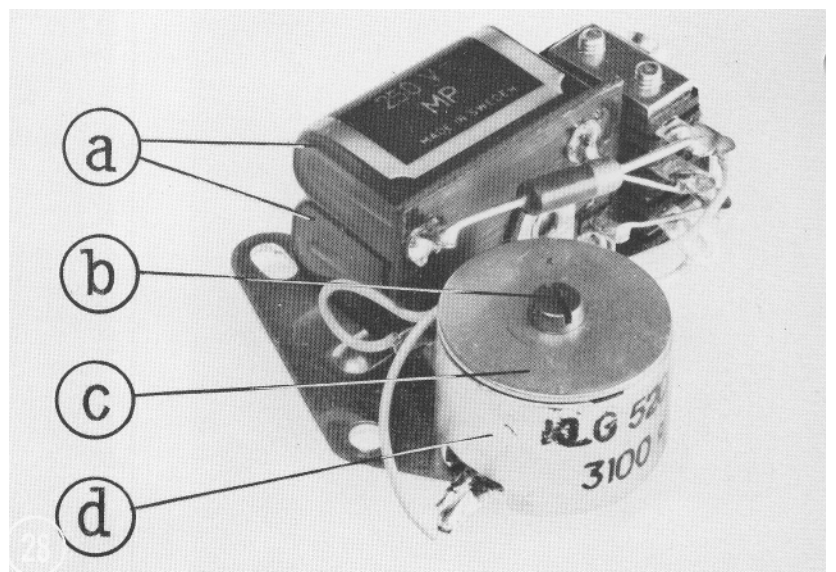
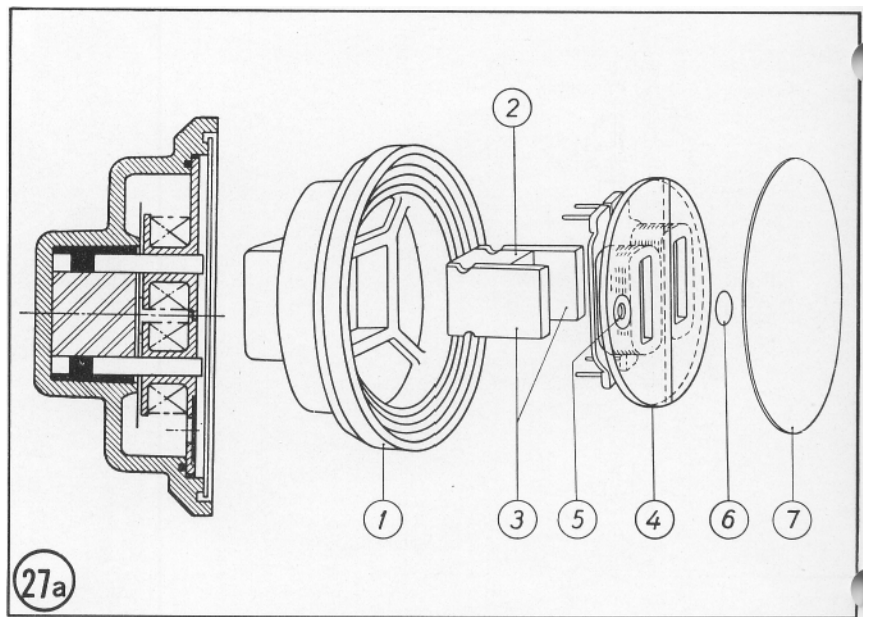
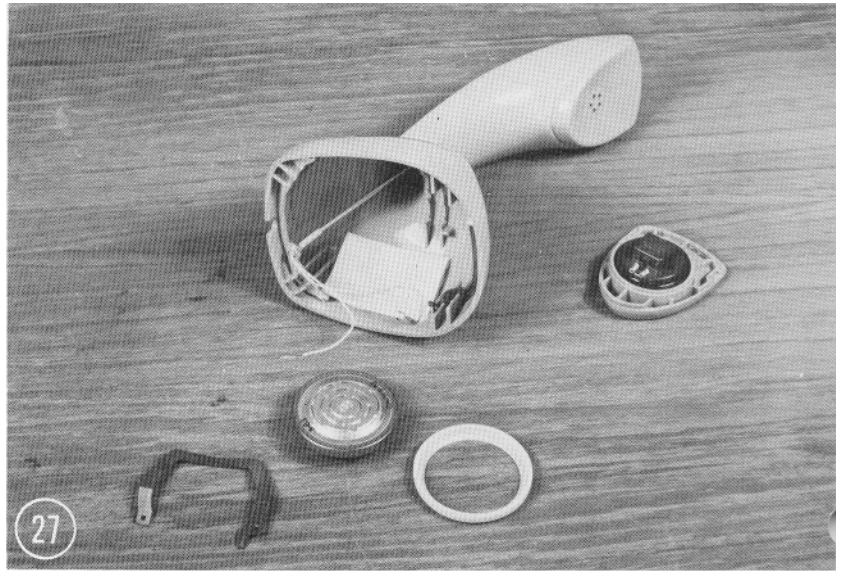

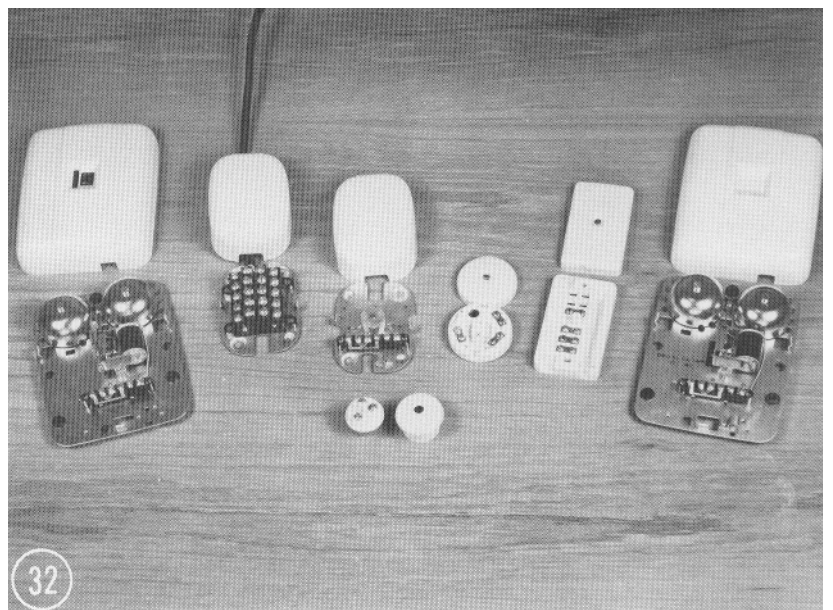
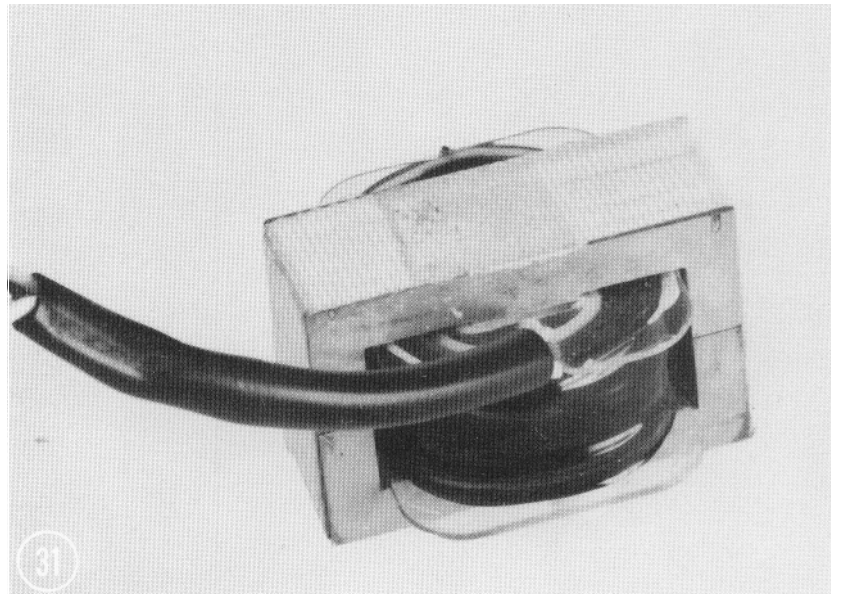
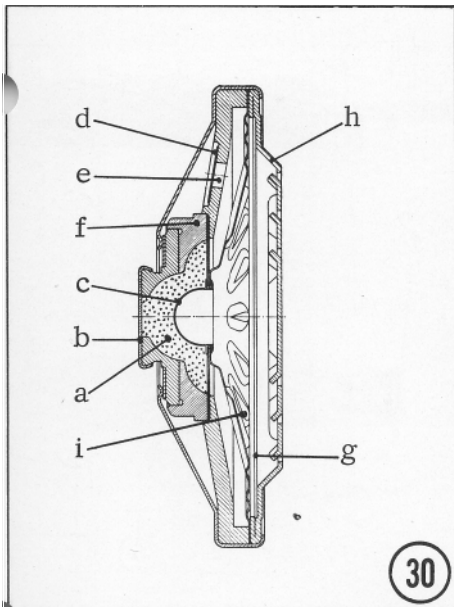
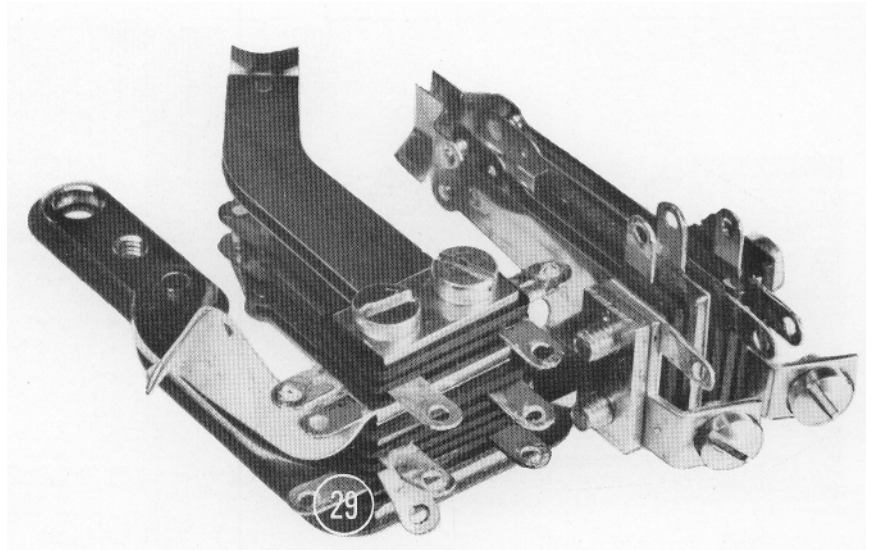

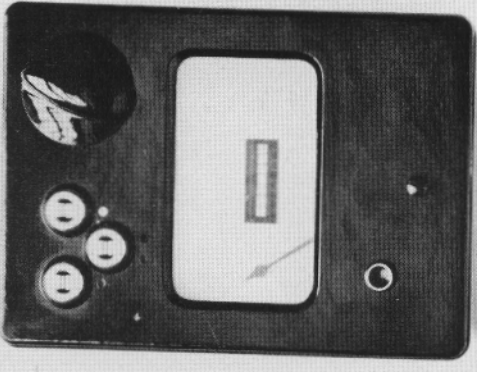

VRT 2503

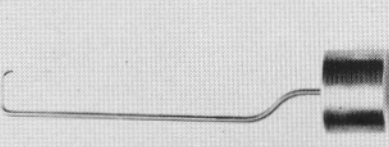

LMV 1111

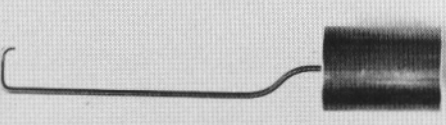

LMV 1115

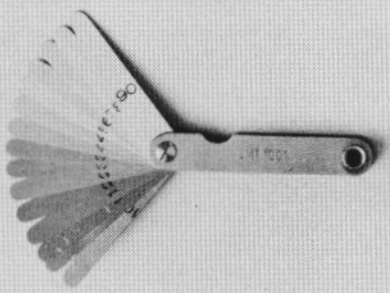

LMT 1001

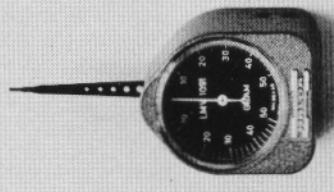

LMV 1091

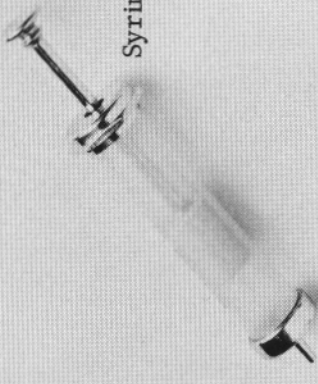

Syring needle 10 ml



Oil MTK 21



Lubricant MTV 37



LSA 1221

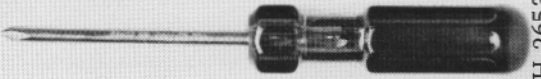

LSH 2653



LSH 2652



LSB 2208

